

steam tube deck ovens

Mondial

ACTIVE

LOGIC



mondial forni
bakery projects



Sturdiness and reliability

Mondial is a multi-deck oven with fixed decks and steam tubes equipped with an important thermal mass that makes it unique due to its gradual cooking features.

The **Mondial** series is recommended for baking products that require a strong heat from the ground and high quantities of steam.

It can be fueled with gas, diesel oil, pellet or wood. Gas bottom channels can be cleaned very easily through the wide inspection doors.

Suitable for baking on pans/tins/trays or directly on the deck sole tiles.

For easier loading/unloading of the oven, it is possible to install different types of loaders: manual, semi-automatic and automatic

Over 65 years of experience of Mondial Forni brand ensure maximum performances in terms of safety, reliability and functionality.



mod. 43 LOGIC with doors opening upwards (optional)



mod. 32 LOGIC with last electrical deck (optional)

Why to choose **Mondial**



Durability

the entire front, the perimeter and on the front door supports are fully in stainless steel

Design

Clean and well defined lines make this professional equipment full of personality, style and elegance.

Sturdiness

Every single part has been designed to boast utmost sturdiness and resistance to shocks that are common inside a bakery shop.

A more pleasant and hygienic workplace

The long-type hood with 300mm depth, ensures a more effective and faster steam extraction for a cleaner workplace.

Taste and flavour of the product

The effectiveness of the steam discharge system enables achieving an ideal moisture and crust for the final product.

High temperature stability and hourly output

The fume ducts made in refractory bricks are fully covered by cement and the tube bundle is equipped with double cross beam for every deck, ensuring high thermal mass to the oven.

Reduced consumption

Heat losses are significantly reduced thanks to the motorized shutter installed on the fume chimney.

At the end of the main bakings it is possible to bake further products with the burner fully switched off for a long period of time, resulting in zero energy costs. These products can be the ones not needing high temperatures like pastries or biscuits

Maximum safety

The safety thermostat installed on the oven guarantees that the oven complies with all the CE safety standards and regulations



"Long Type" hood



doors opening upwards



pellet burners

Main manufacturing features



- Baking temperatures: 300 °C max
- Models: 3 / 4 decks with 2 / 3 / 4 doors per deck
- Baking surface: from 5.10 to 26.80 m²
- Front side, coating and hood in stainless steel
- Baking deck lighting with 2 dichroic lights
- Heating system with ring-shaped steam tubes, one for the top and one for the bottom of each deck, with diameter of 27 mm that directly heat up the deck and the ceiling of every deck.
- Steamer also heated by the combustion fumes that can be accessed from underneath the bench
- Functioning: gas/ diesel oil/ pellet/ wood fired burner
- Oven furnace and gas channels made of special refractory bricks and cement
- Wide inspection inlets for comfortable cleaning of the fume ducts
- Baking deck in cement with clay granules and metal mesh
- Structure built on fixed base
- Insulation in rock wool, minimum thickness per side 20 cm
- Baking deck doors with adjustable stabilizers in stainless steel and tempered glass
- Channeled frame hook

Choose how to load / unload the oven

Mondial series offers various types of loading:

MECHANICAL LIFT

The most simple solution to start from



BUILT-IN LIFT

Very useful for reduced spaces



WHEELED COLUMN PEELS

Automation that makes everything simple



Versions

Mondial series is available in two versions:

LOGIC, versatile and technological, and **ACTIVE**, practical and easy to use.

Versions	ACTIVE	LOGIC
Steam exhauster	standard	AISI 304 stainless steel
Control panel	Electromechanical	Electronic
Motorized damper on gas exhaust chimney for automatic ignition	✗	✓
Facade polycarbonate inserts	✗	✓

Everything under control

Electronic

The main feature is the easy use.

Electro-mechanical **iMEC**

Control that consists exclusively of essential controls.







Type of control	ELECTRONIC	iMEC
Oven temperature	✓	✓
Baking time	✓	✗
Manual steam for single deck	✓	✓
Automatic steam for single deck	✓	✗
Steam for additional prover	✓	✗
ON / OFF burner	✓	✓
Steam suction ON / OFF	✓	✓
ON / OFF steam exhauster	✓	✓
Automatic daily switch-on	✓	✗

✓ = available ✗ = not available

Choose what suits you best

Mondial provides a wide range of fuel systems to meet any requirement.

From pellet system, for users that care for the environment, to practical gas fueled systems.

Description	VIEW	SIDE
 FF GAS / GAS OIL front oven		/
 FLL GAS / GAS OIL CLOSURE PLATE side wood-fired oven		WOOD
 FLS GAS / GAS OIL CLOSURE PLATE side solid fuel oven		PELLET (burner with vertical flame)
 FFL GAS / GAS OIL / WOOD / CLOSURE PLATE front wood-fired oven		/
 FFP PELLETS front pellet-fired oven		/

Optional

Description	ACTIVE	LOGIC
Top deck height 25 cm		✓
Deck height different than standard		✓
AISI 430 stainless steel door		✓
Mobile setters hooking (manual system)		✓
Double steam exhaust dampers (double manual control)		✓
Doors opening upwards		✓
Last electrical deck 32 CS, CO - 33 CS, CO, M	✗	✓
Electric steamer (only for models with the last deck of electric type) 32CS, 32CO, 33CS, 33CO, 33M	✗	✓
"Long Type" hood +300 mm (not available with built-in elevator)		✓
Device to increase the extra steam discharge (recommended with stiffer steam generators)		✓
Stiffer steam generator for each deck for increased steam production for higher steam production		✓
Additional steam generator for prover supply (mod. 3 and 4 decks)		✓
AISI 304 stainless steel steam exhauster	✓	standard
Kit for lateral steam exhauster (right or left) (reduces height to 250 cm)	✓	✓
Hydraulic by-pass		✓
FLL: Right-hand side furnace for solid fuels (wood)		✓
FLP: Right-hand side furnace for solid fuel burners (pellet)		✓
FFL: Front oversized furnace solid fuel (wood)		✓
FFP: Front furnace for pellet burners		✓
Inspection window lateral channel cleaning		✓
Special working table for frontal pellet burner		✓
Front side wire working table for FFL oven		✓
Double door under working table for 2 / 3-doors model (standard on 4-door models)		✓
Buffer battery for displaying the temperature in the absence of voltage	✗	✓
Temperature and baking time display on the hood (delivery time longer than standard)		✓

✓ = available ✗ = not available

Technical data

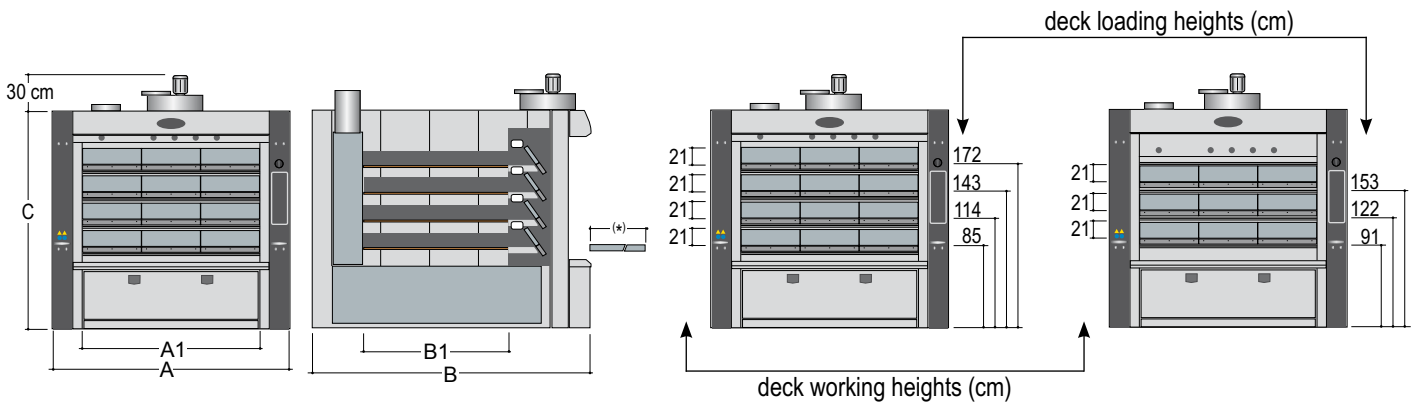

Models	Decks N°	Doors for deck N°	Baking surface m ²	Working heights cm	Dimensions (cm)					Thermal power		Real power kW (400 V)	Weight kg
					deck		overall			kW	kcal/h		
					A1	B1	A	B	C				
32 CX	2	2	5,1	21-21-21	124	138	190	269	230	58,0	49.700	1,5	6.000
32 CS			6,1			165		295		68,0	58.000		6.700
32 CO			7,6			205		335		79,0	68.000		7.300
32 C			8,2			218		348		84	72.000		7.550
33 CX	3	3	7,7	21-21-21	186	138	252	269	230	79,0	68.000	1,5	7.350
33 CS			9,2			165		295		97,0	83.000		7.900
33 CO			11,4			205		335		110,0	94.000		9.500
33 C			12,2			218		348		115	99.000		9.200
33 M			13,6			244		375		132,0	113.000		9.900
34 CS	4	4	12,2	19-19-19-19	248	165	314	295	230	115,0	99.000	1,5	9.950
34 CO			15,2			205		335		140,0	120.000		11.800
34 C			16,2			218		348		146	125.000		11.500
34 M			18,2			244		375		165,0	140.000		12.250
34 L			20,2			271		402		180,0	155.000		13.050
42 CS	2	2	8,1	19-19-19-19	124	165	190	295	230	91,0	78.000	1,5	7.300
42 CO			10,1			205		335		102,0	88.000		8.000
42 C			10,8			218		348		108	93.000		8.250
43 CX	3	3	10,3	19-19-19-19	186	138	252	269	230	102,0	88.000	1,5	8.100
43 CS			12,3			165		295		107,0	92.000		8.700
43 CO			15,2			205		335		140,0	120.000		9.700
43 C			16,2			218		348		146,0	125.000		10.050
43 M			18,2			244		375		163,0	140.000		10.800
43 L	20,2	271	402	180,0	155.000	11.500							
44 CS	4	4	16,4	19-19-19-19	248	165	314	295	230	149,0	128.000	1,5	10.800
44 CO			20,3			205		335		175,0	150.000		12.400
44 C			21,6			218		348		182,0	156.000		12.600
44 M			24,2			244		375		200,0	172.000		13.450
44 L			26,8			271		402		227,0	195.000		14.350



Mondial Forni believes in sustainable development through mindful use and enhancement of natural resources. According to this philosophy, Mondial Forni decided to reduce the size of its prints making 50% of the paper available for other purposes, while equally reducing the use of inks. Help us sustain this program by downloading the catalogues in electronic format directly from the website.



www.mondialforni.com

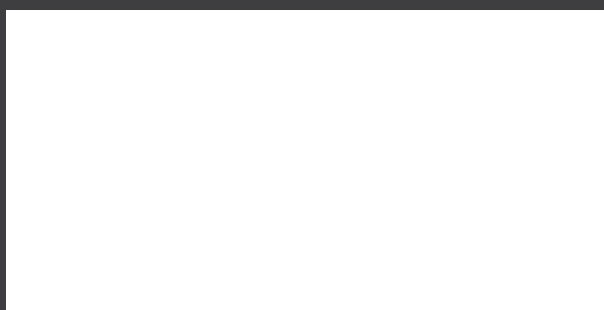

mondial forni
bakery projects

Mondial Forni S.p.A. - via dell'Elettronica, 1 - 37139 Verona - Italy
Tel. +39 045 8182511 - Fax +39 045 8518210 mbox@mfb.it www.mondialforni.com

Technical data and photos are intended to be supplied for information purposes and do not involve any modifications that might be made.